

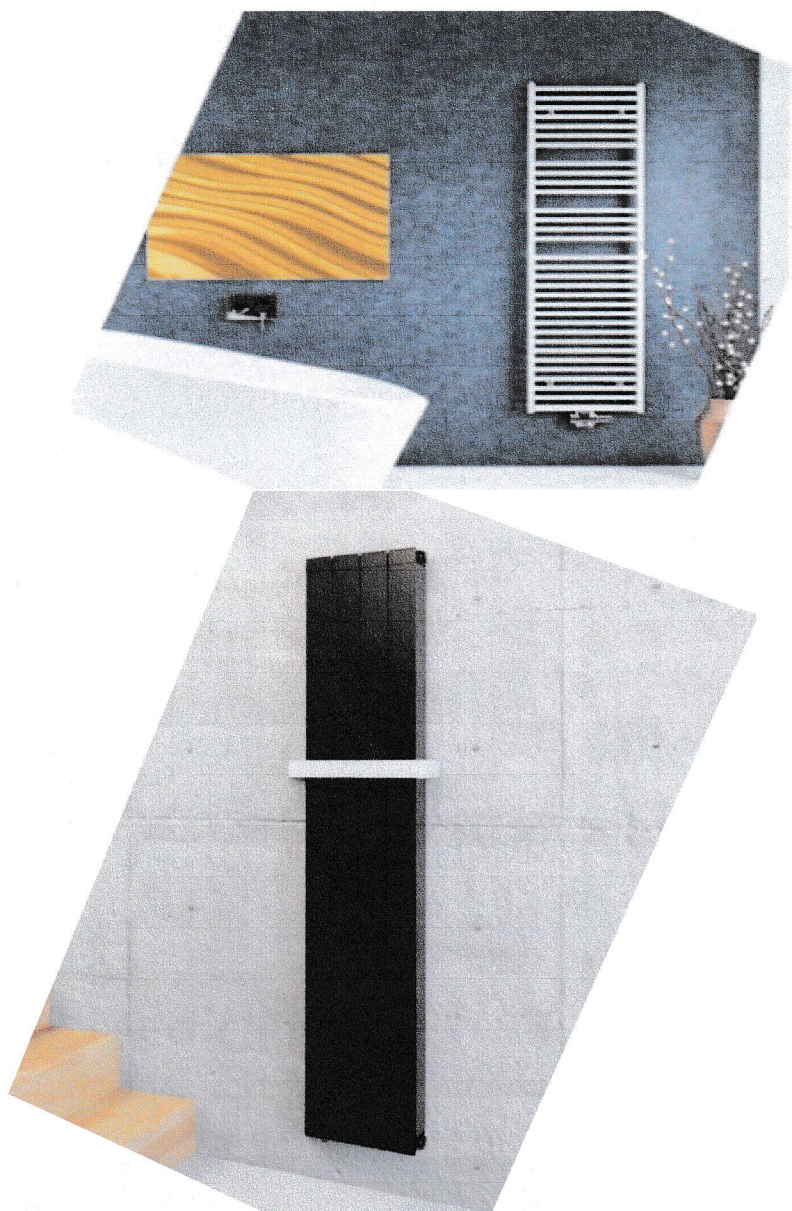

aklimat[®]
ALUMINIUM DESIGN RADIATORS

CENNÍK 2022 SK

Radiátorov, príslušenstva,
doplnkov
a náhradných dielov



Cenník je platný od 01.09.2022 až do vydania nového alebo do zrušenia aktuálneho. Vyhradujeme si právo na zmenu technických a iných údajov bez predchádzajúceho upozornenia. Obrázky majú len informačný charakter. Chyby nie sú vylúčené. Ceny sú s 20% DPH.

WINTEC Slovakia s.r.o., Jána Hollého 381/7, 969 01 Banská Štiavnica,
Tel.: +421 903 708365, Web: www.aklimat.sk, Email: aklimat@aklimat.sk, info@win-tec.sk

Autorské práva vyhradené © 2021 – AKLIMAT d.o.o.

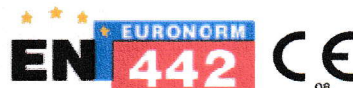

Systém certifikovaný podľa ISO 9001 v ISO 14001

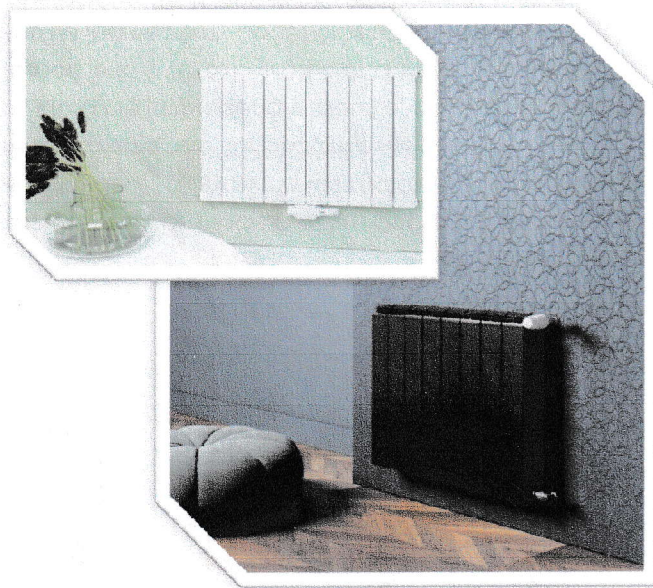

CLASSIC M a CLASSIC T

rozmer radiátorov Classic M a Classic T:

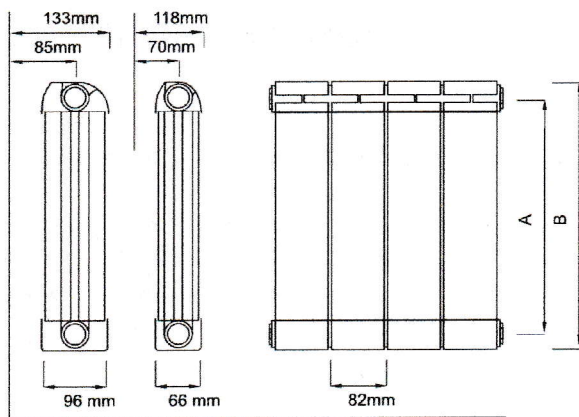

M

T

ponúkané rozmery pripojenia

150	200	250	300	310	350	374	380	400	450
460	500	505	515	520	524	530	540	550	570
580	590	600	650	700	740	750	800	820	824
840	845	850	900	915	930	950	1000	1024	1030
1100	1200	1300	1400	1500	1600	1700	1800	1900	2000

Možné štandardné výšky pre M/T, MD/TD, ML/TL, MM/TM a MMH/TMH, celková výška rad. je +41mm



Typ Classic M / Classic T	Pripojenie A (mm)	Celková výška B (mm)	objem vody v litri. v článku	Tepelný výkon (W) DIN EN 442			Cena (€) / článok Classic M / T
				ΔT 50 W/čl. 75/65/20 °C	ΔT 60 W/čl. 90/70/20 °C	ΔT 30 W/čl. 55/45/20 °C	
M200 / T200	200	241	0,15	62 / 46	78 / 58	32 / 23	18,99
M350 / T350	350	391	0,2	90 / 69	115 / 88	46 / 35	21,99
M500 / T500	500	541	0,25	117 / 91	149 / 115	59 / 46	23,49
M524 / T524	524	565	0,26	121 / 94	154 / 119	61 / 48	23,99
M570 / T570	570	611	0,27	129 / 100	164 / 127	65 / 51	24,99
M600 / T600	600	641	0,28	136 / 104	174 / 132	69 / 53	25,99
M650 / T650	650	691	0,29	142 / 110	181 / 141	71 / 56	26,99
M700 / T700	700	741	0,32	150 / 113	192 / 144	75 / 57	28,99
M800 / T800	800	841	0,34	166 / 122	212 / 156	83 / 62	29,99
M900 / T900	900	941	0,37	181 / 140	232 / 179	90 / 71	33,99
M930 / T930	930	971	0,38	185 / 143	238 / 183	92 / 72	36,99
M1000 / T1000	1000	1041	0,4	196 / 150	251 / 192	97 / 76	38,99
M1024 / T1024	1024	1065	0,41	199 / 154	256 / 196	98 / 77	39,49
M1200 / T1200	1200	1241	0,47	225 / 173	289 / 222	111 / 86	44,99
M1400 / T1400	1400	1441	0,53	252 / 195	325 / 251	124 / 97	49,99
M1600 / T1600	1600	1641	0,59	279 / 219	359 / 281	137 / 108	55,99
M1800 / T1800	1800	1841	0,65	305 / 237	393 / 306	150 / 116	62,99
M2000 / T2000	2000	2041	0,71	330 / 257	425 / 331	163 / 128	69,99

Názov	Ident	Cena / kus (€)
Sada pre radiátor s ventilom M a T, PRAVÝ, HEIMEIER	593375	33,99
Sada pre radiátor s ventilom M a T, PRAVÝ, DANFOSS	593379	33,99
Sada pre radiátor s ventilom M a T, ĽAVÝ, HEIMEIER	593377	33,99
Sada pre radiátor s ventilom M a T, ĽAVÝ, DANFOSS	593381	33,99

Príplatok za ML/MD a TL/TD: 9 €

Príplatok za stredné pripojenie MM / TM: 16 €

Príplatok za stredné pripojenie MMH / TMH: 24 €

Možnosti pripojenia (pozri strana 16):

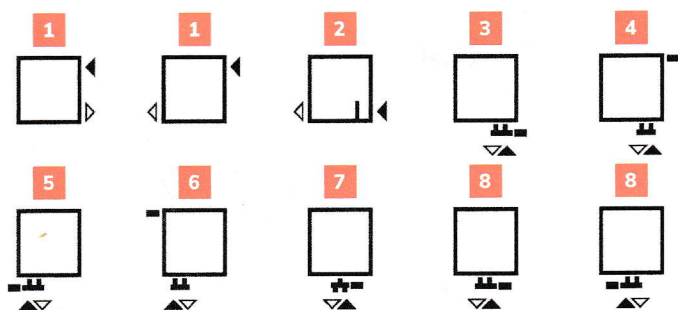

Poznámky:

- Aklimat Classic T je dostupný iba s párnym počtom článkov
- Zostavujeme dĺžku do 20 článkov. Vyššie radiátory (od 1200 do 2000 mm) iba do 10 článkov.
- Doplatok pre zostavenie radiátorov na 10/20 článkov **-35,-€**
- Cena článku, ktorá nie je uvedená v tabuľke vyššie, sa rovná prvej nasledujúcej vyššej cene z tabuľky.
- Základnou farbou je RAL 9016. Príplatok za farebné prevedenie: +35 %.
- Pripojenie **MM/TM** len v nepárnom počte článkov, pripojenie **MMH/TMH** len v párnom počte článkov.

CLASSIC M v CLASSIC T BIMETAL

Radiátor s oceľovou zabudovanou rúrou - pre systém s nie čistou alebo agresívnou vodou

rozmery radiátorov Classic M a Classic T:

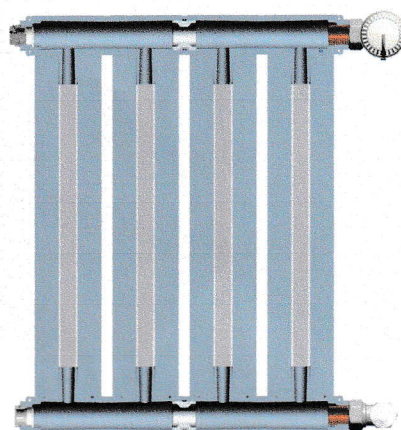
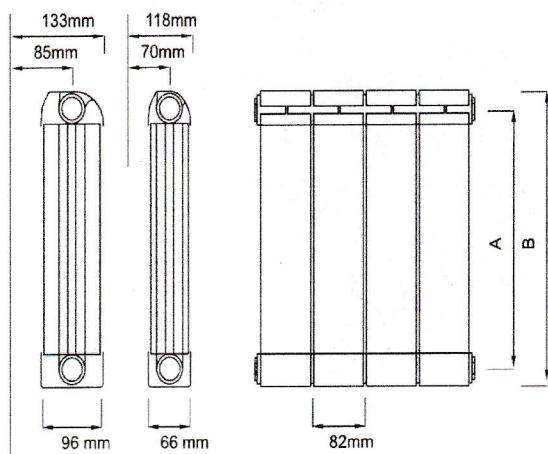

Typ CLASSIC M v CLASSIC T BIMETAL	Pripojenie A (mm)	Celková výška B (mm)	Hmotnosť článku M / T (kg)	Tepelný výkon (W) DIN EN 442			Cena (€) / článok Classic M / T
				$\Delta T 50 \text{ W/}^\circ\text{C}$ 75/65/20 °C	$\Delta T 60 \text{ W/}^\circ\text{C}$ 90/70/20 °C	$\Delta T 30 \text{ W/}^\circ\text{C}$ 55/45/20 °C	
M200 / T200	200	241	0,78 / 0,70	62 / 46	78 / 58	32 / 23	22,99
M350 / T350	350	391	1,05 / 0,93	90 / 69	115 / 88	46 / 35	25,99
M500 / T500	500	541	1,33 / 1,11	117 / 91	149 / 115	59 / 46	29,99
M524 / T524	524	565	1,38 / 1,22	121 / 94	154 / 119	61 / 48	30,49
M570 / T570	570	611	1,45 / 1,28	129 / 100	164 / 127	65 / 51	30,99
M600 / T600	600	641	1,51 / 1,34	136 / 104	174 / 132	69 / 53	32,99
M650 / T650	650	691	1,62 / 1,43	142 / 110	181 / 141	71 / 56	33,99
M700 / T700	700	741	1,71 / 1,50	150 / 113	192 / 144	75 / 57	34,99
M800 / T800	800	841	1,89 / 1,66	166 / 122	212 / 156	83 / 62	38,99
M900 / T900	900	941	2,08 / 1,83	181 / 140	232 / 179	90 / 71	41,99
M930 / T930	930	971	2,13 / 1,87	185 / 143	238 / 183	92 / 72	42,99
M1000 / T1000	1000	1041	2,26 / 1,99	196 / 150	251 / 192	97 / 76	45,99
M1024 / T1024	1024	1065	2,30 / 2,01	199 / 154	256 / 196	98 / 77	46,99
M1200 / T1200	1200	1241	2,64 / 2,31	225 / 173	289 / 222	111 / 86	53,99
M1400 / T1400	1400	1441	3,01 / 2,63	252 / 195	325 / 251	124 / 97	60,99
M1600 / T1600	1600	1641	3,38 / 2,96	279 / 219	359 / 281	137 / 108	65,99
M1800 / T1800	1800	1841	3,76 / 3,28	305 / 237	393 / 306	150 / 116	69,99
M2000 / T2000	2000	2041	4,13 / 3,61	330 / 257	425 / 331	163 / 128	79,99

Poznámky:

- Aklimat Classic M/T Bimetal je dostupný vo všetkých veľkostiach ako Aklimat Classic M/T.
- Všetky príplatky sú rovnaké ako pri Aklimat Classic M/T.
- Možné sú všetky pripojovacie možnosti ako pri Aklimat Classic M/T.

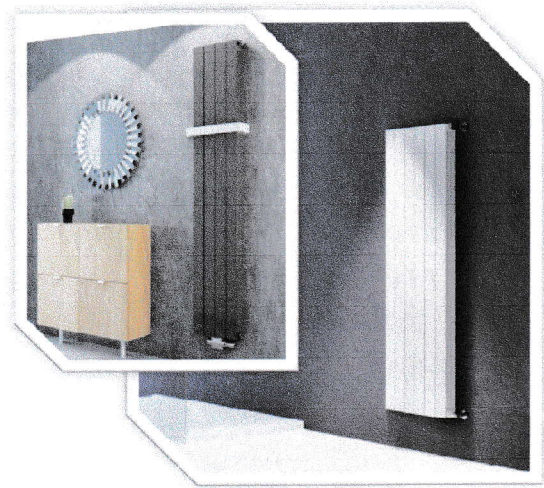

CUBO M a CUBO T

Rozmery radiátorov Cubo M a Cubo T:

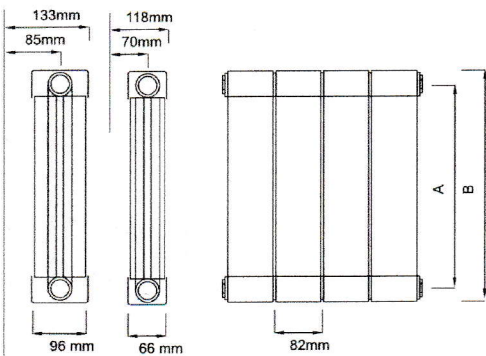

Možnosti pripojenia (pozri strana 16):

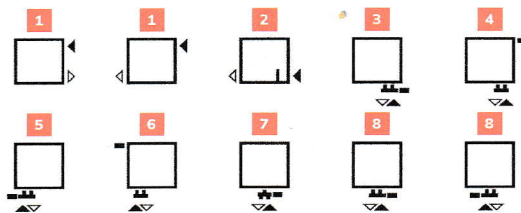

CM

CT

Typ Cubo M / Cubo T	Pripojenie A (mm)	Celková výška B (mm)	Hmotnosť článku (kg)	Tepelný výkon (W) DIN EN 442			Cena (€) / článok CUBO M / T
				$\Delta T 50 \text{ W/}^\circ\text{C}$ 75/65/20 °C	$\Delta T 60 \text{ W/}^\circ\text{C}$ 90/70/20 °C	$\Delta T 30 \text{ W/}^\circ\text{C}$ 55/45/20 °C	
CM200 / CT200	200	241	0,69 / 0,61	62 / 46	78 / 58	32 / 23	20,99
CM350 / CT350	350	391	0,90 / 0,78	90 / 69	115 / 88	46 / 35	22,92
CM500 / CT500	500	541	1,11 / 0,96	117 / 91	149 / 115	59 / 46	26,99
CM600 / CT600	600	641	1,25 / 1,08	136 / 104	174 / 132	69 / 53	29,99
CM700 / CT700	700	741	1,40 / 1,19	150 / 113	192 / 144	75 / 57	33,99
CM900 / CT900	900	941	1,68 / 1,43	181 / 140	232 / 179	90 / 71	39,99
CM1000 / CT1000	1000	1041	1,82 / 1,54	196 / 150	251 / 192	97 / 76	44,99
CM1200 / CT 1200	1200	1241	2,11 / 1,78	225 / 173	289 / 222	111 / 86	55,99
CM1400 / CT 1400	1400	1441	2,11 / 1,78	252 / 195	325 / 251	124 / 97	59,99
CM1600 / CT1600	1600	1641	2,67 / 2,25	279 / 219	359 / 281	137 / 108	67,99
CM1800 / CT1800	1800	1841	2,96 / 2,48	305 / 237	393 / 306	150 / 116	73,99
CM2000 / CT2000	2000	2041	3,24 / 2,72	330 / 257	425 / 331	163 / 128	79,99

Príplatok za CML/CMD v CTL/CTD: 9 €

Príplatok za stredné pripojenie: CMM / CTM: 16 €

Príplatok za stredné pripojenie CMMH / CTMH: 24 €

Poznámky:

- Aklimat Cubo T je dostupný iba s párnym počtom článkov.
- Zostavujeme dĺžku do 20 článkov. Vyššie radiátory (od 1200 do 2000 mm) iba do 10 článkov.
- Cena za výšku, ktorá nie je v cenníku - na vyžiadanie.
- Základnou farbou je RAL 9016. Príplatok za ďalšie farby: 35 %.
- Pripojenie CMM/CTM iba nepárny počet článkov, pripojenie CMMH/CTMH v párnom počte článkov.



VILLA

Typ VILLA	Ident	Pripojenie A (mm)	Celková výška B (mm)	Hmotnosť (kg)	Tepelný výkon (W) DIN EN 442			Cena (€) / článok
					$\Delta T 50$ W/čl. 75/65/20 °C	$\Delta T 60$ W/čl. 90/70/20 °C	$\Delta T 30$ W/čl. 55/45/20 °C	
V500x880	595020	500	880	6,58	441	550	239	249,00
V500x1100	595022	500	1100	8,08	546	681	295	299,00
V500x1320	595068	500	1320	9,67	650	811	351	329,00
V500x1540	595024	500	1540	11,26	753	940	406	369,00
V500x1760	595080	500	1760	12,85	856	1069	461	399,00
V400x880	595083	400	880	6,08	406	506	220	229,00
V400x1100	595085	400	1100	7,39	502	627	271	279,00
V400x1320	595087	400	1320	8,87	598	746	323	319,00
V400x1540	595089	400	1540	10,33	693	865	374	359,00
V400x1760	595091	400	1760	11,8	788	983	424	389,00

Poznámky:

- Cena zahŕňa radiátor, konzolu a ukončovaciu súpravu.
- Základná farba je RAL9016. Príplatok za farebné prevedenie: +35%.
- Príplatok za stredné pripojenie: 35 €

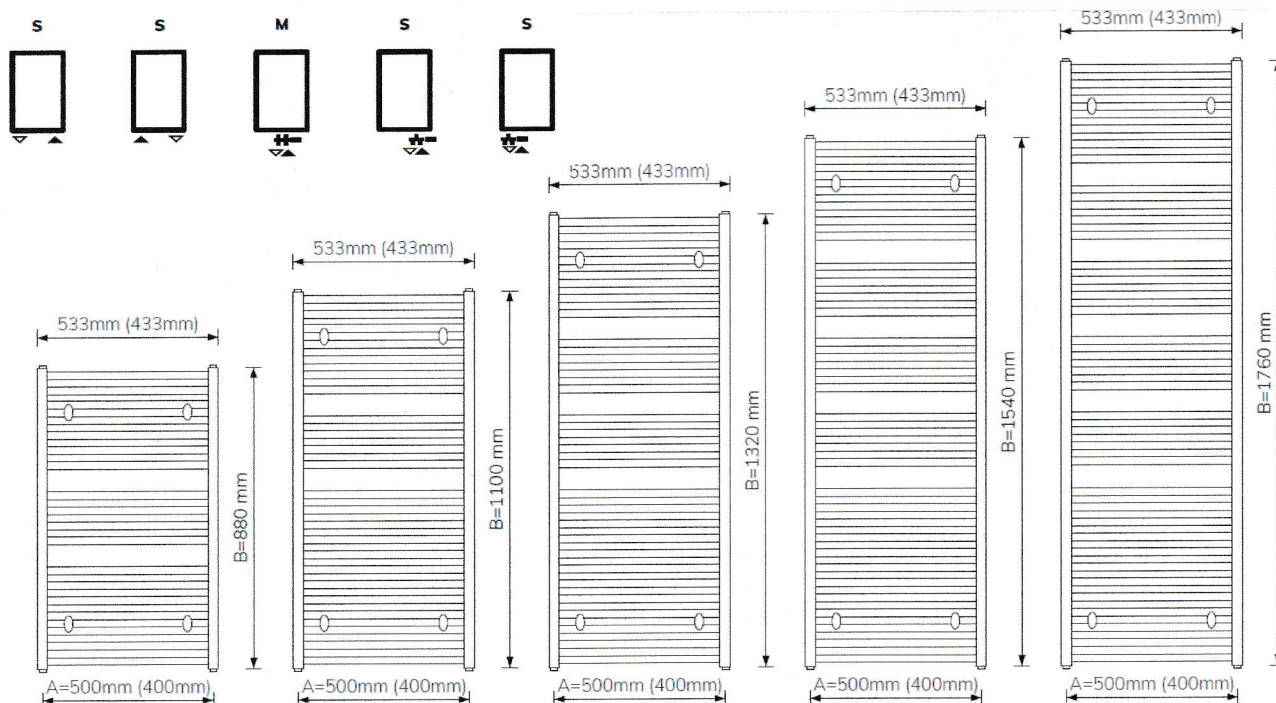



SMART a SMART ELEGANT

Rozmery radiátorov rady SMART:

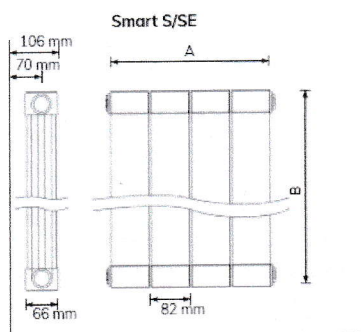

Možnosti pripojenia:

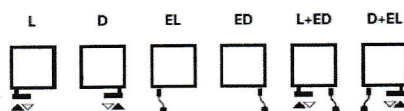

T

Typ Smart / Smart Elegant	Šírka A (mm)	Celková výška B (mm)	Obsah vody (l)	Tepelný výkon (W) DIN EN 442			Cena (€) / článok			
				ΔT 50 W/čl. 75/65/20 °C	ΔT 40 W/čl. 90/70/20 °C	ΔT 30 W/čl. 55/45/20 °C	Smart - biela	Smart - farebná	Smart Elegant - biela	Smart Elegant - farebná
1400 S/SE	328	1441	2,2	780	1004	388	359,00	429,00	529,00	599,00
1600 S/SE	328	1641	2,4	876	1124	432	379,00	449,00	549,00	529,00
1800 S/SE	328	1841	2,6	948	1224	464	399,00	499,00	479,00	549,00

Poznámky:

- Súprava Smart špeciálne pre Vaše kúpeľňu obsahuje: radiátor s dvomi ukončovacími lištami, konzolami, držiakom na uteráky
- Základná farba je matná biela R9016FM; farebný radiátor podľa škály farieb
- Základná súprava: ukončovacie lišty vo farbe radiátorov, držiak na uteráky vo farbe (DB703, DB 701, R9016FM)
- Základná súprava: ukončovacie lišty a držiak na uteráky vo farbe podľa vášho výberu, radiátor matný biely (R9016FM)
- Farebná súprava: vo farbe podľa vášho výberu ako vo farebnej schéme













Radiátor model T Elegant podľa vášho výberu:

Príplatok k bežnej cene za farbu radiátora T podľa želania: 145 €

PRÍSLUŠENSTVO

	Názov	Typ	EAN	Ident	Cena / kus (€)
	Súprava ukončovacích prvkov pre radiátor M a T s odvodušňovacím ventilom G1/2"	biely	3838862035932	590972	11,99
		farba	3838862035949	590973	14,49
	Súprava ukončovacích prvkov pre radiátor MD v ML s odvodušňovacím ventilom G1/2"	biely	3838862040554	593242	13,49
		farba	3838862040561	593243	16,99
	Súprava ukončovacích prvkov pre radiátor MM, MMH a TM, TMH s odvodušňovacím ventilom G1/2"	biely	3838862040592	593246	15,49
		farba	3838862040622	593247	19,49
	Sada pre radiátor s ventilom M a T, PRAVÝ , HEIMEIER	biely	3838862436043	593375	33,99
		farba	3838862436050	593376	35,99
	Sada pre radiátor s ventilom M a T, LAVÝ , HEIMEIER	biely	3838862436067	593377	33,99
		farba	3838862436074	593378	35,99
	Sada pre radiátor s ventilom M a T, PRAVÝ , DANFOSS	biely	3838862436081	593379	33,99
		farba	3838862436098	593380	35,99
	Sada pre radiátor s ventilom M a T, LAVÝ , DANFOSS	biely	3838862436104	593381	33,99
		farba	3838862436111	593382	35,99
	Súprava pre zostavu pre radiátor M a T	-	3838862035956	590974	3,99
	Smerovač toku vody	-	3838862380964	593810	5,99
	Termostatická hlavica Aklimat	M30 x 1,5	3838862217949	516567	27,99
	Dvojité priame pripojenie pre dvojrúrový systém	DR2-1/2"	3838862375700	128733	29,99
	Dvojité šikmé pripojenie pre dvojrúrový systém	DK2-1/2"	3838862375717	128734	29,99
	Dvojité priame pripojenie pre jednorúrový systém	DR1-1/2"	3838862375748	128738	59,99
	Dvojité šikmé pripojenie pre jednorúrový systém	DK1-1/2"	3838862375724	128739	59,99
	Univerzálny konektor s reguláciou, priamy - šikmý	U2-1/2"	3838862375731	128740	79,99
	Konektor MULTILUX 4-HALO - Chróm, priamy - šikmý - jedno - dvojrúrový systém	Heimeier 9690-43.000	3838862417219	520200	259,00
	Konektor MULTILUX 4-HALO - Biely priamy - šikmý - jedno - dvojrúrový systém	Heimeier 9690-42.000	3838862417226	520201	209,00
	Priamy ventil VUA 40 pre radiátor MM a TM s dvojrúrovým systémom	-	3838862217451	128583	69,99
	Priamy ventil VUA 40 pre radiátor MM a TM s jednorúrovým systémom	-	3838862217444	128584	74,99
	Šikmý ventil VUA 40 pre radiátor MM a TM s dvojrúrovým systémom	-	3838862217420	128591	74,99
	Šikmý ventil VUA 40 pre radiátor MM a TM s jednorúrovým systémom	-	3838862217437	128590	79,99
	Termostatická hlavica Herz	M28 x 1,5	3838862313504	128592	29,99

PRÍSLUŠENSTVO

	Názov	Typ	EAN	Ident	Cena / kus (€)
	Elektrický ohrievač CINI 600 W (l = 335 mm)	biely	3838862040677	593460	129,00
		chróm	3838862417356	593501	139,00
	Elektrický ohrievač CINI 900 W (l = 405 mm)	biely	3838862040684	593461	139,00
		chróm	3838862417363	593502	149,00
	Elektrický ohrievač CINI 1200 W (l = 455 mm)	biely	3838862217413	593463	149,00
		chróm	3838862417370	593503	159,00
Elektrický ohrievač CINI 1500 W (l = 480 mm)	biely	3838862040691	593463	159,00	
	chróm	3838862417387	593504	169,00	
	Zvlhčovač vzduchu (pre radiátor M)	40x19x132 mm	3838862313917	593717	4,99
	Čistiaca kefa	1000 mm	3838862035390	102776	19,99
	Korekčná farba	-	3838862036526	092767	31,99
	Sprej RAL 9016 400 ml	-	3838862381015	099564	19,99
	Šablóna na montáž	-	3838862040714	590966	7,99
	Kľúč na dokončenie	-	3838862035963	590986	22,99
	Kľúč na montáž	700 mm	3838862017273	590233	79,99
	Tesniaca matica pre medené rúry (pár)	C 15	3838862217567	128257	8,99
		C 16	3838862217574	128280	
		C 18	3838862217581	128325	
	Tesniaca matica pre plastové rúry (pár)	P 16	3838862217581	128325	11,99
		P 18	3838862217581	128325	
	Automatický odvzdušňovací ventil G1/2"	-	3838862040707	069004	19,99
	Automatický bezpečnostný ventil 3 bar - 1/2"	-	3838862417417	593813	24,99

KONZOLY

Typ	Kód	Vhodné pre	EAN	Ident	Balenie	Cena / kus (€)
Nástenná konzola	E 350	M/T 350-450	3838862024257	580439	kus	4,99
	E 500	M/T 500-600	3838862024264	580440	kus	6,49
	E 650	M/T 650-850	3838862017259	580441	kus	6,99
	E 900	M/T 900-1024	3838862017266	580442	kus	7,99
	ET 350	M/T 350-450	3838862017211	590822	kus	5,99
	ET 500	M/T 500-600	3838862017228	590821	kus	7,49
	ET 650	M/T 650-850	3838862017235	590823	kus	7,99
	ET 900	M/T 900-1024	3838862017242	590824	kus	8,99
	EN	M/T 250-2000	3838862017396	580453	kus	7,49
	A 1	M/T 200-350	3838862029764	590904	pár	7,49
UNI	M/T 200-2000	3838862436036	590836	kus	4,99	
Podlahová konzola	D1 Jednoradová pre M/T	M/T 200-900	3838862380995	590472	kus	19,99
	D2 Dvojradohá pre M/T	M/T 200-900	3838862381008	590473	kus	24,99

Odporúčania pre počet konzol v závislosti od veľkosti radiátora (počet článkov):

Počet článkov	2	3 - 15	16 - 20	21 - 26
Počet konzol E, EN	1	2	3	4
Počet konzol A1 - pár	1	2	3	4

Nástenné konzoly

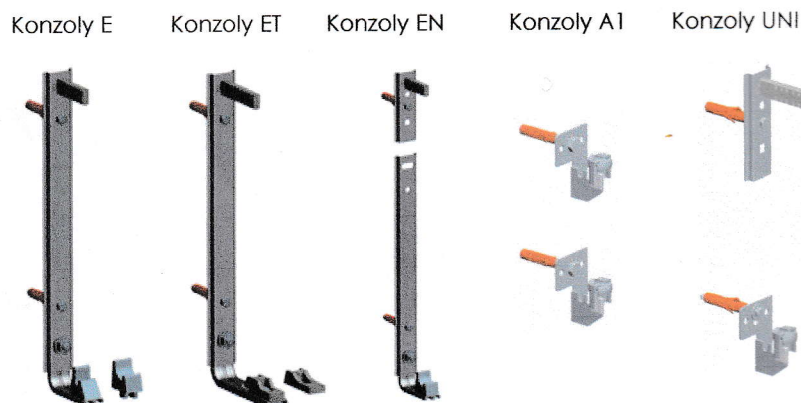

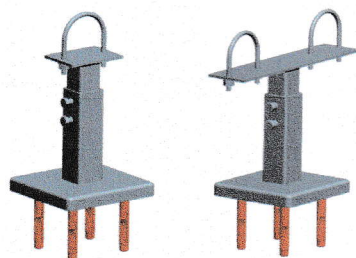

Podlahové konzoly

D1 jednoradová D2 dvojradohá



DODATOČNÁ výbava

	Názov	Dĺžka (mm)	Farba	EAN	Ident	Cena / kus (€)
	Držiak na uteráky	M (pre 4 alebo viac článkov)	biela	3838862381404	594150	59,00
			DB701	3838862381411	594151	59,00
			DB703	3838862381428	594152	59,00
			RAL	3838862417134	594153	89,00
		T (pre 4 alebo viac článkov)	biela	3838862381435	594155	55,00
			DB701	3838862381442	594156	55,00
			DB703	3838862381459	594157	55,00
			RAL	3838862417141	594158	85,00
		M (pre 5 alebo viac článkov)	biela	3838862381466	594160	65,00
			DB701	3838862381473	594161	65,00
			DB703	3838862381480	594162	65,00
			RAL	3838862417158	594163	95,00
		T (pre 5 alebo viac článkov)	biela	3838862381497	594165	59,00
			DB701	3838862381503	594166	59,00
			DB703	3838862381510	594167	59,00
			RAL	3838862417165	594168	89,00
	Držiak na uteráky	M (pre 4 články)	biela	3838862381527	594170	75,00
			DB701	3838862381534	594171	75,00
			DB703	3838862381541	594172	75,00
			RAL	3838862417172	594173	119,00
		T (pre 4 články)	biela	3838862381558	594175	75,00
			DB701	3838862381565	594176	75,00
			DB703	3838862381572	594177	75,00
			RAL	3838862417189	594178	115,00
		M (pre 5 článkov)	biela	3838862381589	594180	75,00
			DB701	3838862381596	594181	75,00
			DB703	3838862381602	594182	75,00
			RAL	3838862417196	594183	119,00
		T (pre 5 článkov)	biela	3838862381619	594185	75,00
			DB701	3838862381626	594186	75,00
			DB703	3838862381633	594187	75,00
			RAL	3838862417202	594188	119,00
	Vešiak okrúhly 20x27	Pre radiátor M a T	biela	3838862381633	594250	14,99
			RAL	3838862417202	594251	16,99



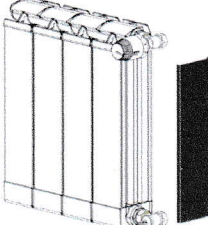





PRÍSLUŠENSTVO

Názov	Farba	Typ	Ident	Typ	Ident	Cena / kus (€)
 <p>Ukončovacia lišta pre Classic M / T a Cubo M / T</p>	biela	M 200	593296	T 200	593465	10,99
	Farba		593315		593483	13,99
	biela	M 350	593297	T 350	593466	10,99
	Farba		593316		593484	13,99
	biela	M 500	593298	T 500	593467	13,99
	Farba		593317		593485	16,99
	biela	M 524	593299	T 524	593468	13,99
	Farba		593318		593486	16,99
	biela	M 570	593301	T 570	593469	13,99
	Farba		593319		593487	16,99
	biela	M 600	593302	T 600	593470	14,99
	Farba		593321		593488	18,99
	biela	M 650	593304	T 650	593471	14,99
	Farba		593322		593489	18,99
	biela	M 700	593369	T 700	593472	15,99
	Farba		593372		593490	19,99
	biela	M 800	593370	T 800	593473	16,99
	Farba		593373		593491	21,99
	biela	M 900	593305	T 900	593474	18,99
	Farba		593323		593492	23,99
	biela	M 930	593306	T 930	593475	19,99
	Farba		593324		593493	24,99
	biela	M 1000	593371	T 1000	593476	20,99
	Farba		593374		593476	25,99
	biela	M 1024	593307	T 1024	593477	20,99
	Farba		593325		593495	25,99
	biela	M 1200	593308	T 1200	593478	25,99
	Farba		593326		593496	31,99
	biela	M 1400	593309	T 1400	593479	27,99
	Farba		593327		593497	35,99
biela	M 1600	593310	T 1600	593480	31,99	
Farba		593328		593498	40,99	
biela	M 1800	593312	T 1800	593481	34,99	
Farba		593329		593499	43,99	
biela	M 2000	593313	T 2000	593482	39,99	
Farba		593330		593500	51,99	

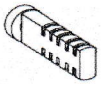

NÁHRADNÉ DIELY



	Názov	EAN	Ident	Cena / kus (€)
	Termostatická hlavica Aklimat M24x1,5 (03-070-160)	3838862375762	517943	31,99
	Termostatická hlavica Aklimat M30x1,5 (03-070-140)	3838834033836	514280	31,99
	Súprava pre zostavenie a dokončenie rúrkových radiátorov	3838862038988	595029	25,99
	Súprava ukončovacích prvkov pre radiátory 3/4"	3838862040639	593252	17,99
	Súprava ukončovacích prvkov pre radiátor M a T pre jednorúrovňový systém G1/2"	3838862040592	593244	14,99
	Pripojenie 1"-1/2" PRAVÉ biele	3838862313528	593339	1,59
	Pripojenie 1"-1/2" ĽAVÉ biele	3838862313535	593340	1,59
	Zarážka 1/2"	3838862313627	593349	1,49
	Odvzdušňovací ventil G1/2"	3838862313634	593350	1,99
	Ventil TG PRAVÝ pre M a T, HEIMEIER	3838862314501	593793	33,99
	Ventil TG ĽAVÝ pre M a T, HEIMEIER	3838862314495	593792	33,99
	Ventil TG PRAVÝ pre M a T, DANFOSS	3838862436128	593814	33,99
	Ventil TG ĽAVÝ pre M a T, DANFOSS	3838862436135	593815	33,99
	Súprava prvkov pre konzolu ET	3838862313696	593356	2,99
	Súprava prvkov pre konzolu E	3838862313702	593357	2,99
	Tesnenie pre radiátor K (MALÉ) okr.18,2x3 Balený a cena za 10 kusov	3838862313719	593358	6,99
	Tesnenie pre radiátor K (VEĽKÉ) okr.33x3,5 Balený a cena za 10 kusov	3838862313726	593359	7,99

NÁHRADNÉ DIELY

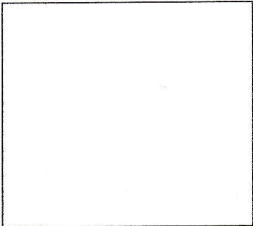
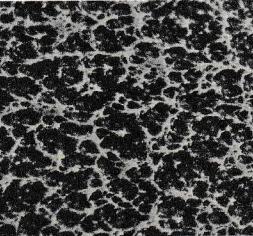
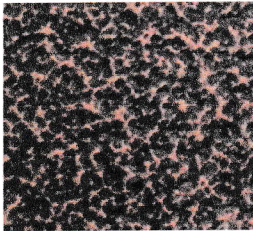
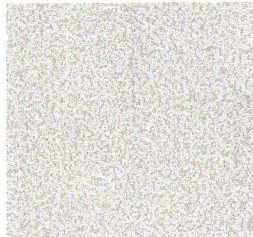
	Názov	EAN	Ident	Cena / kus (€)
	Tesnenie pre zostavu s drážkou PLOCHÉ okr. 40,4/31x1 Balenie a cena za 10 kusov	3838862313597	593346	2,99
	Tesnenia FPM - ČIERNE, pre servis okr.31,42x2,62 Balenie a cena za 10 kusov	3838862436029	580474	9,99
	Tesnenie SILIKÓN - BIELE pre radiátory s drážkou okr.31,34x3,53 Balenie a cena za 10 kusov	3838862314631	593365	5,99
	Rozpierka pre konzolu E 17x60 mm PVC	3838862313641	593351	0,99
	Rozpierka pre konzolu ET 17x77 mm PVC	3838862313658	593352	0,99
	Držiak pre konzolu E - Aklimat MS 30x20x38 mm PVC	3838862313672	593354	1,49
	Držiak pre konzolu E - Aklimat M 30x20x38 mm PVC	3838862313665	593353	1,49
	Držiak pre konzolu E - Aklimat T 31x21x26 mm PVC	3838862375694	580471	1,49
	Podložka pre konzolu E a ET okr.23,5x7,8x6 PVC	3838862313689	593355	0,99
	Odvzdušňovací kľúč Aklimat (2 ks)	3838862313924	593718	1,99

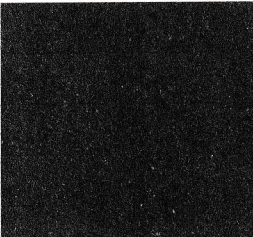
COLOR AKLIMAT

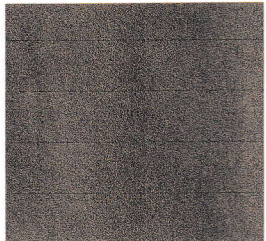
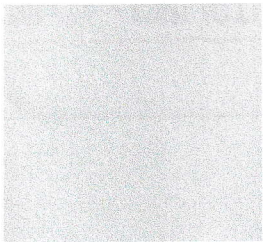
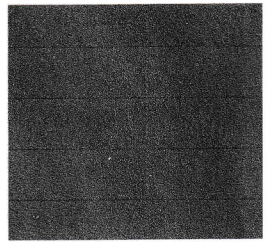
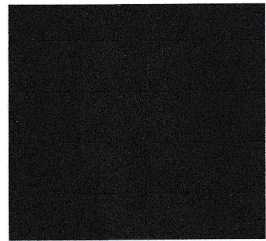
Color	Aklimat code
	R9016 (Standard color aklimat)
	BS200 (Black silver)
	BC210 (Black copper)
	WG500 (White gold)
	DB701 (Light gray metallic)
	DB703 (Dark gray metallic)

Color	Aklimat code
	MMCAR (Metallic matt Carbon)
	MST30 (MAT Style 30, deep mat)
	MCL01 (MAT Classic 01, Imitation matt chrome)
	MCL37 (MAT Classic 37, deep mat)
	MTR07 (MAT Trend 7, deep mat)
	R1036 (Old gold)

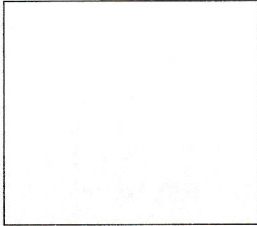
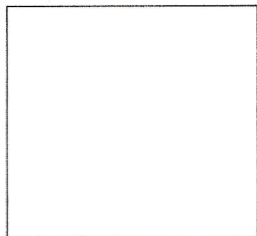
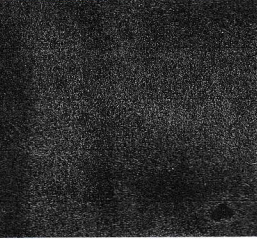
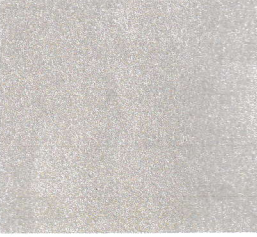
Color	Aklimat code
	R9010
	R9016FM (White feinstruktur matt)
	SQ822 (Smokey Quartz)
	SA137 (Sandy)

MOŽNOSTI PRIPOJENIA

1		<p>STANDARD</p> <p>M/T ; CM/CT</p>
2		<p>STANDARD</p> <p>M/T ; CM/CT</p> <p>+ Smerovač toku vody</p>
3		<p>MD/TD ; CMD/CTD</p>
4		<p>VENTIL</p> <p>MD/TD ; CMD/CTD</p> <p>MD/TD - CMD/CTD + SET = MV-D</p> <p>+ Súprava pre radiátory s ventilom - PRAVÁ, Heimeier, Danfoss</p>
5		<p>ML/TL ; CML/CTL</p>
6		<p>VENTIL</p> <p>ML/TL ; CML/CTL</p> <p>ML/TL - CML/CTL + SET = MV-L</p> <p>+ Súprava pre radiátory s ventilom - ĽAVÁ, Heimeier, Danfoss</p>
7		<p>MM/TM ; CMM/CTM</p>
8		<p>MMH/TMH ; CMMH/CTMH</p>